

1580 OPTILUX PRO

1000 SERIES

LUMEN™
Truss



1580 OPTILUX PRO PROFILE

1000 Series



Cross-section dimensions:

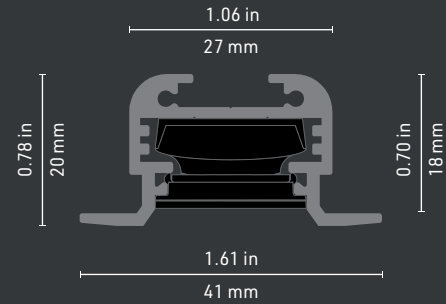

The edge design of the 1580 Optilux Pro profile harmonizes with your décor and allows for a very secure recessed installation. Use with our spring brackets for a fast and easy installation.

A high-tech gem: What makes the 1580 Optilux Pro Profile so innovative? Its lens incorporates an LED light source with a CRI of 95+, allowing you to direct the light exactly where you want it with exceptional quality and color rendition. Even better, its anti-reflective technology offers unparalleled visual comfort. Another innovation exclusive to LumenTruss™!

FEATURES

- Length of light source in 6.5 in (16 cm) increments only
- CRI 95+ with PCB: black or white
- Choice of 4 color temperatures (2700 K, 3000 K, 3500 K et 4000 K)
- 2 beam angles: 30° × 30° (336 lm/ft) or 10° × 45° (345 lm/ft)
- Anti-reflective technology reducing eye fatigue
- Also available in a black finish
- Made of ALCOA 6063-T5 aluminum alloy for superior heat dissipation and increased LED light source life
- Rated life of up to 50,000 hours
- Indoor use, 24 V

OPTIONS







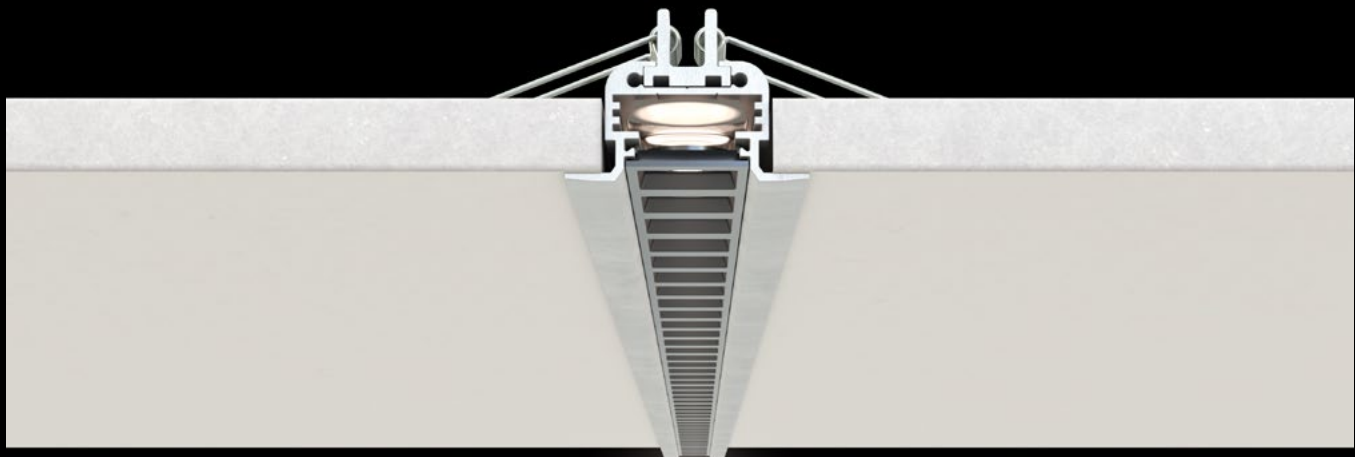

LINEAR WEIGHT





0.28 lbs/ft, 0.42 kg/m (without lens or insert)



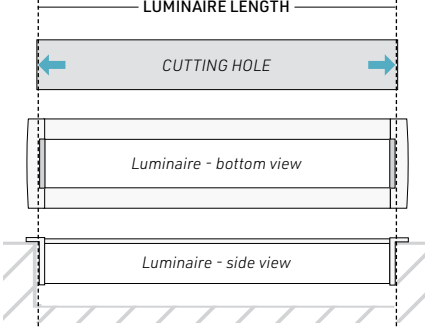



| PROFILE | LENSES | MOUNTING HARDWARE | LENGTH |
|---|---|--|--|
|  <p>1580 - 1580 Profile, alu</p> |  <p>OPT1 - Optilux Black</p> |  <p>SP - Spring bracket</p> | <p>Choose prespecified length</p> <ul style="list-style-type: none"> 7 - 7" 13 - 13.5625" 20 - 20.1250" 26 - 26.6875" 33 - 33.25" 39 - 39.8125" 46 - 46.3750" 53 - 52.9375" 59 - 59.5" 66 - 66.0625" 72 - 72.6250" 79 - 79.1875" 85 - 85.75" 92 - 92.3125" |
|  <p>1581 - 1580 Profile, black</p> |  <p>OPT2 - Optilux white</p> |  <p>NO - No mounting hardware</p> | |
| |  <p>OPT3 - Optilux Gold</p> | | |
| | | |  |
| PROFILE | LENS | MOUNTING HARDWARE | LENGTH |

| COLOR TEMPERATURE | LUMEN PACKAGE/BEAM ANGLE* | LEAD IN | USAGE | POWER SUPPLY/CONTROL | *NOTES |
|--|--|--|-------------------------------------|---|---|
| <ul style="list-style-type: none">  27 - 2700K  30 - 3000K  35 - 3500K  40 - 4000K | <p>OP1 - 336 LM / 7.0W FT / 95+CRI 30x30 Smooth spot</p> <p>OP2 - 345 LM / 7.0W FT / 95+CRI 10x45 Asymmetric</p> | <p>HW3 - Hardwire 3 FT</p> <p>HW6 - Hardwire 6 FT</p> <p>HW9 - Hardwire 9 FT</p> <p>HWX - Hardwire custom FT</p> | <p>I - IP22 indoor dry location</p> | <p>A - Non-dimming</p> <p>B - ELV dimming 120V AC</p> <p>C - ELV dimming 120/277 VAC**</p> <p>D - 0/10V dimming 120/277 VAC</p> <p>F - DMX</p> <p>G - Lutron - HI-LUME PREMIER 0,1% Eco System 24V/96W</p> <p>I - Casambi CBU-A2D-0/10V- DALI-Bluetooth 100/277 VAC</p> <p>J - Casambi CBU-PWM4-4CH- Bluetooth 100/277 VAC</p> <p>K - Casambi CBU-TED-CV-Trail edge dim-Bluetooth 120 VAC</p> <p>NO - No driver</p> | <p>*The light output is provided in lumens per foot, for a CCT of 4000K and a clear lens. Please refer to the optics page for CCT and translucency conversion factors.</p> <p>** Only available in 96W - 24V Driver</p> <div style="border: 1px solid black; padding: 5px; text-align: center;"> <p>TITLE</p> <p>24</p> <p>1000</p> </div> |
| COLOR TEMPERATURE CCT | LUMEN PACKAGE/BEAM ANGLE | LEAD IN | USAGE | POWER SUPPLY/CONTROL | |

NOTES

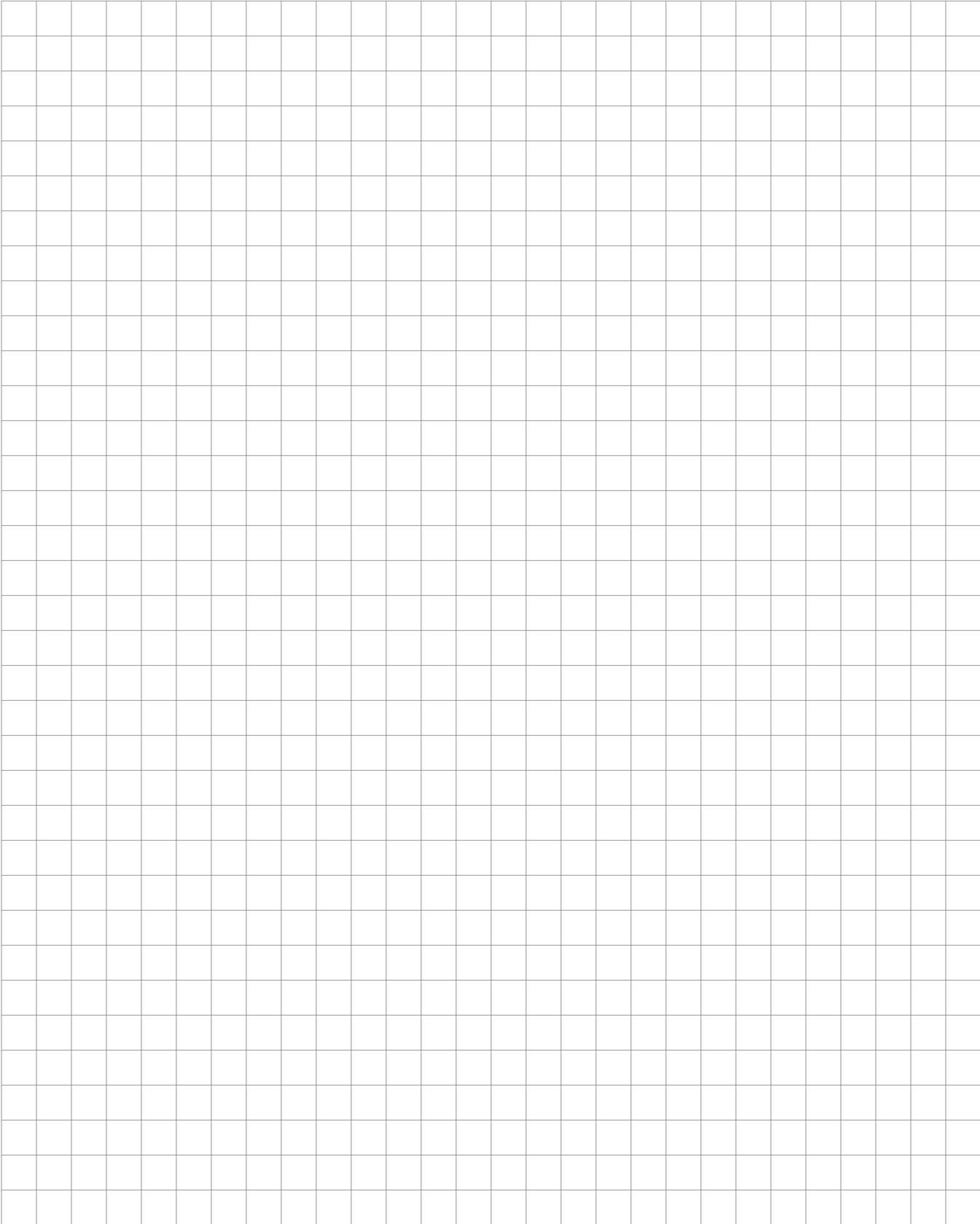



CONTACT US

ADDRESS

9221 Edison
Montreal, Quebec,
H1J 1T4, Canada

FAX

1.514.903.0649

EMAIL

info@lumentruss.com

PHONE

1.855.384.3384

WEBSITE

www.lumentruss.com



MADE IN
NORTH AMERICA

LUMEN™
Truss