

1580 OPTILUX PRO PROFILE

1000 Series

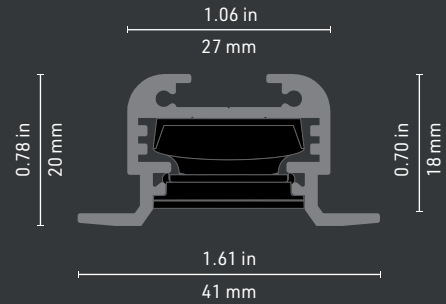

Cross-section dimensions:



The edge design of the 1580 Optilux Pro profile harmonizes with your décor and allows for a very secure recessed installation. Use with our spring brackets for a fast and easy installation.

A high-tech gem: What makes the 1580 Optilux Pro Profile so innovative? Its lens incorporates an LED light source with a CRI of 95+, allowing you to direct the light exactly where you want it with exceptional quality and color rendition. Even better, its anti-reflective technology offers unparalleled visual comfort. Another innovation exclusive to LumenTruss™!

FEATURES

- Length of light source in 6.5 in (16 cm) increments only
- CRI 95+ with PCB
- Choice of 4 color temperatures (2700 K, 3000 K, 3500 K et 4000 K)
- 2 beam angles: 30° × 30° (336 lm/ft) or 10° × 45° (345 lm/ft)
- Anti-reflective technology reducing eye fatigue
- Also available in a black finish
- Made of ALCOA 6063-T5 aluminum alloy for superior heat dissipation and increased LED light source life
- Rated life of up to 50,000 hours
- Indoor use, 24 V

OPTIONS







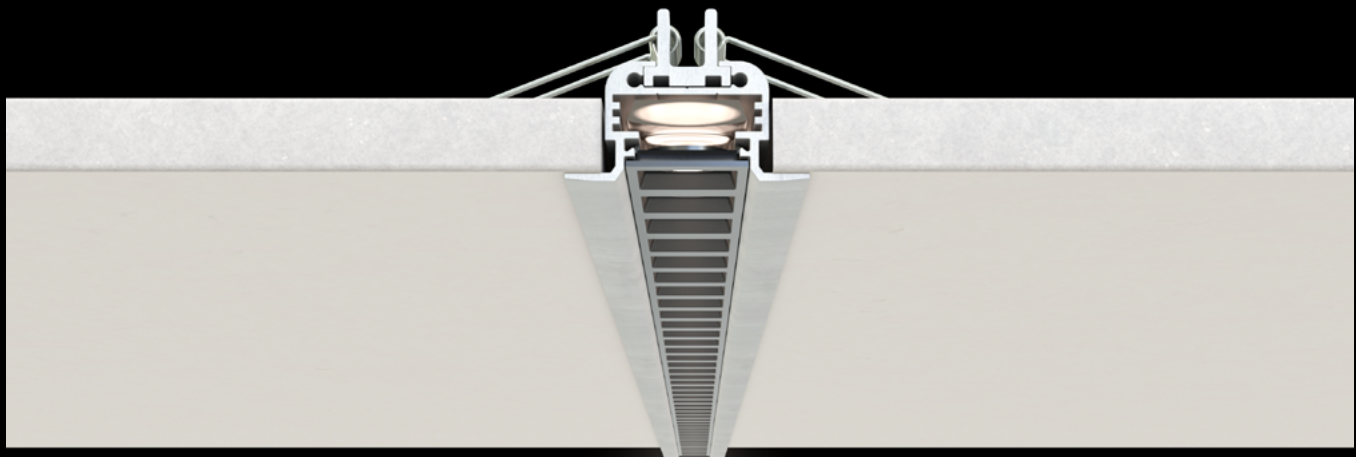

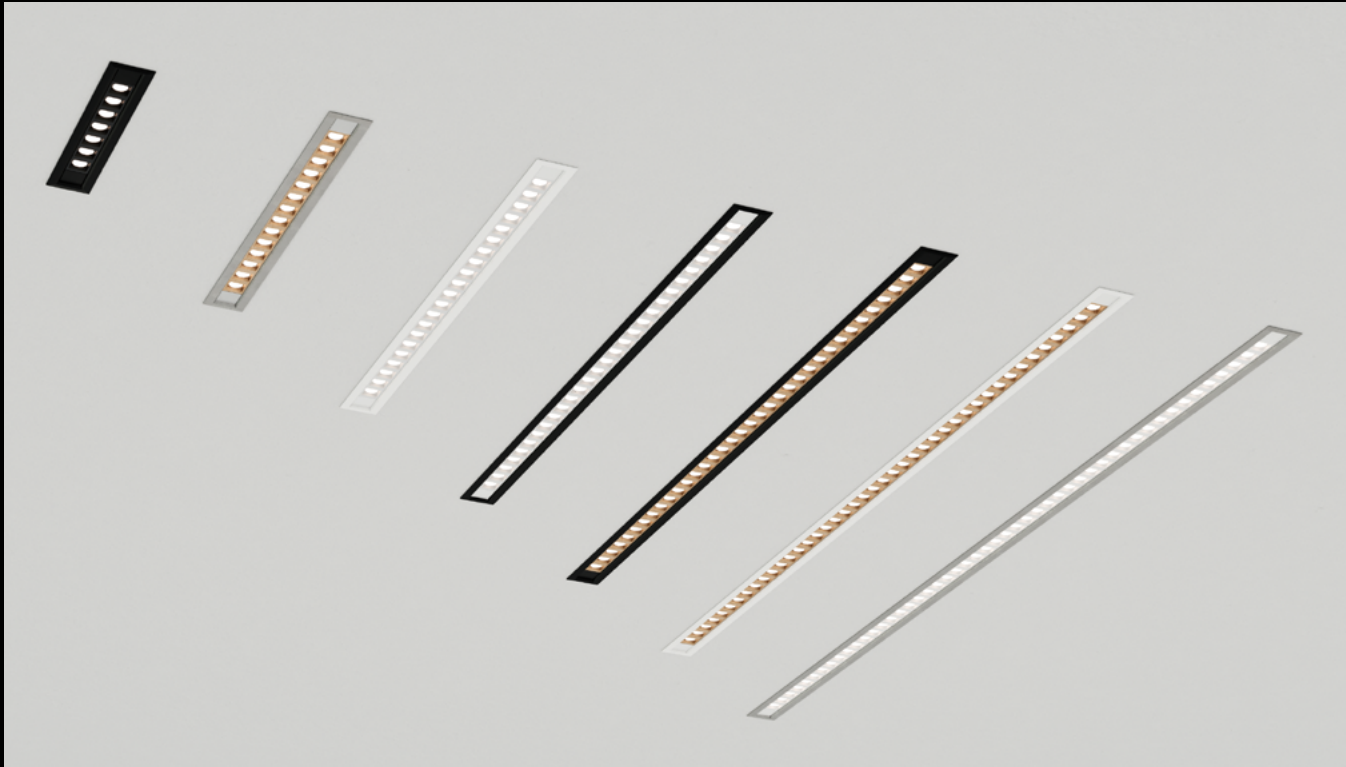
LINEAR WEIGHT

0.28 lbs/ft, 0.42 kg/m (without lens or insert)

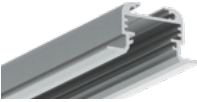

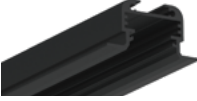





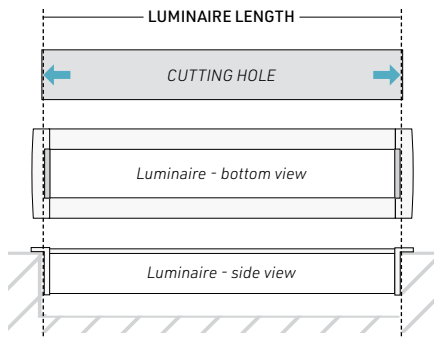

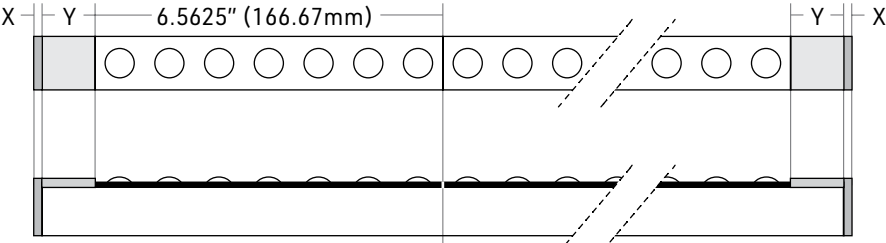

PROFILE	LENSES	MOUNTING HARDWARE	LENGTH
 <p>1580 - 1580 Profile, alu</p>	 <p>OPT1 - Optilux Black</p>	 <p>SP - Spring bracket</p>	<p>Choose prespecified length</p> <p>7 - 7 1/16" (7.003") 14 - 13 3/16" (13.565") 21 - 20 1/8" (20.126") 28 - 26 7/16" (26.688") 35 - 33 1/4" (33.250") 42 - 39 9/16" (39.812") 49 - 46 3/8" (46.374") 56 - 52 15/16" (52.935") 63 - 59 1/2" (59.497") 70 - 66 1/8" (66.059") 77 - 72 5/8" (72.621") 84 - 79 3/16" (79.183") 91 - 85 3/4" (85.745") 98 - 92 5/16" (92.306")</p> <p>NOTE: Blind covers will be added as necessary to accommodate electrical wiring or if the length indicated by the client is different from prespecified values in this column.</p> <p>To order custom length blind covers, please contact your representative.</p>
 <p>1581 - 1580 Profile, black</p>	 <p>OPT2 - Optilux white</p>	 <p>NO - No mounting hardware</p>	
	 <p>OPT3 - Optilux Gold</p>		



PROFILE	LENS	MOUNTING HARDWARE	LENGTH
 <p>6.5625" (166.67mm)</p>			
<p>Parameters for 1 Optilux section:</p>  <p>Light sources: 7 Length: 6.5625" (166.67mm) Power: 3W Light output: 172.5 lm</p> <p>Blind cover (Y): variable length End cap (X): 5.6mm</p>			

COLOR TEMPERATURE	LUMEN PACKAGE/BEAM ANGLE*	LEAD IN	USAGE	POWER SUPPLY/CONTROL	*NOTES
 27 - 2700K  30 - 3000K  35 - 3500K  40 - 4000K	<p>OP1 - 378 LM / 5.5W FT / 95+CRI 30x30 Smooth spot</p> <p>OP2 - 345 LM / 5.5W FT / 95+CRI 45x10 Asymmetric **</p>	<p>HW3 - Hardwire 3 FT HW6 - Hardwire 6 FT HW9 - Hardwire 9 FT HWX - Hardwire custom FT</p>	<p>I - IP22 indoor dry location</p>	<p>A - Non-dimming B - ELV dimming 120V AC C - ELV dimming 120/277 VAC*** D - 0/10V dimming 120/277 VAC F - DMX G - Lutron - HI-LUME PREMIER 0.1% Eco System 24V/96W I - Casambi CBU-A2D-0/10V-DALI-Bluetooth 100/277 VAC J - Casambi CBU-PWM4-4CH-Bluetooth 100/277 VAC K - Casambi CBU-TED-CV-Trail edge dim-Bluetooth 120 VAC</p> <p>NO - No driver</p>	<p>*The light output is provided in lumens per foot, for a CCT of 4000K.</p> <p>** Not available for the 4000K.</p> <p>*** Only available in 96W - 24V Driver.</p> <div style="border: 1px solid black; padding: 5px; text-align: center;"> <p>TITLE 24 PAGE</p> </div>

COLOR TEMPERATURE CCT LUMEN PACKAGE/BEAM ANGLE LEAD IN USAGE POWER SUPPLY/CONTROL