

4500 PROFILE

4000 Series

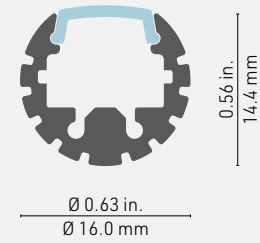

Cross-section dimensions:



MEET OUR MAGIC WAND!

A well cherished secret that we just have to brag about. The 4500 is a slim but extremely versatile display solution. With its **ultra-compact size** and its **complete freedom of lighting direction**, and accepting most LED engines¹, you will find many ways to install it with its wide variety of accessories.

(1) Accepts LED engines ranging up to 10mm wide.

FEATURES

- Ultra-compact size with a diameter of only 16mm (5/8in).
- All of the 4500 brackets allow adjusting lighting direction along the axis as desired.
- Custom length by sections of 2 to 240 inches (6m).
- Made of ALCOA 6063-T5 aluminum alloy increasing heat dissipation.
- Its use increases the lifetime of your LED engine.
- Compatible with multiple installation accessories.
- Designed to meet North American woodworking standards.

OPTIONS











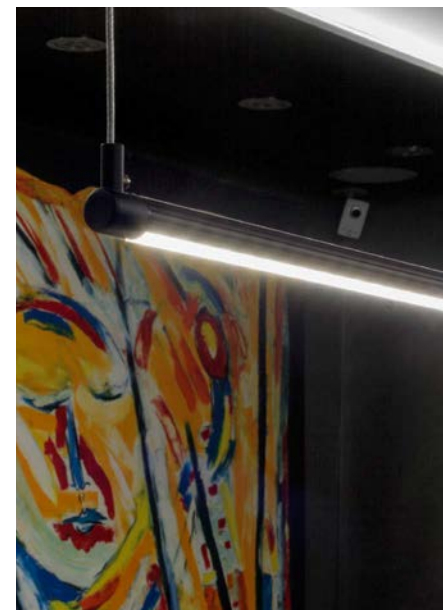













LED ENGINE COMPATIBILITY

Compatible with LED engines up to **10mm** wide.

LINEAR WEIGHT

0.147 lbs/ft, 0.218 kg/m



PROFILE	LENSES	MOUNTING HARDWARE	CANOPY	LENGTH
 <p>4500 - 4500 Profile, alu</p>  <p>4501 - 4501 Profile, black</p>	<p>CL - Clear lens</p>  <p>OX - Optiflex lens</p>  <p>OP - Opal lens</p>  <p>SIL - SiLens</p>  <p>NO - No lens</p> 	<p>FL - Flat bracket</p>  <p>U0 - "U" bracket, Alu</p>  <p>P0 - "P" bracket, Alu</p>  <p>VS - Arm kit vertical surface Maximum = 12"</p>  <p>VI - Arm kit vertical insert Maximum = 12"</p>  <p>HS - Arm kit horizontal surface Maximum = 12"</p>  <p>HI - Arm kit horizontal insert Maximum = 12"</p>  <p>NO - No mounting hardware</p>  <p>SUS - 4500 endcap suspension kit with 15ft. coax. cable</p> 	<p>NOTE: Only available with SUS bracket (suspension)</p>  <p>Remote driver canopy plate See Appendix 2 on page 158 CR0 - Alu CR1 - Black CR2 - White</p>  <p>Integrated driver in canopy See Appendix 2 on page 158 CI0 - Alu CI1 - Black CI2 - White</p>  <p>Integrated driver & suspension kit See Appendix 2 on page 158 CIK0 - Alu CIK1 - Black CIK2 - White</p>  <p>NO - No canopy</p> 	<p>Custom length by sections of 2 to 60 inches (1.5m).</p>
PROFILE	LENS	MOUNTING HARDWARE	CANOPY	LENGTH

COLOR TEMPERATURE

	24 - 2400K
	27 - 2700K
	30 - 3000K
	35 - 3500K
	42 - 4200K
	53 - 5300K (LHP only)
	62 - 6200K (LP only)
	WD1 - 2200-2700K 14W
	WD3 - 2700-3500K 14W
	TW1 - Tunable White 11W
	TW2 - Tunable White 19W
	RGB1 - RGB 14W
	RGB2 - RGB 19W

COLOR TEMPERATURE CCT

LUMEN PACKAGE*

LP0	- 128 LM / 1.5W FT / 90+CRI
LP1	- 160 LM / 1.5W FT / 90+CRI
LP2	- 255 LM / 3.0W FT / 90+CRI
LP3	- 308 LM / 4.5W FT / 90+CRI
LP4	- 400 LM / 5.8W FT / 90+CRI
LHP	- 700 LM / 7.0W FT / 95+CRI

Note: Not applicable for Warmdim (WD), Tunable White (TW) & RGB color temperatures

LUMEN PACKAGE

LEAD IN/OUT

HW3	- Hardwire 3 FT
HW6	- Hardwire 6 FT
HW9	- Hardwire 9 FT
HWX	- Hardwire custom FT
DC3	- DC plug 3 FT
DC6	- DC plug 6 FT
DC9	- DC plug 9 FT
DCX	- DC plug custom FT
SUS	- Coaxial wire 15 Ft
NO	- No lead

LEAD IN LEAD OUT

USAGE

I - IP22 indoor dry location

USAGE

POWER SUPPLY/CONTROL

A	- Non-dimming
B	- ELV dimming 120V AC
C	- ELV dimming 120/277 VAC**
D	- 0/10V dimming 120/277 VAC
E	- Non-dimming DC plug in
F	- DMX
G	- Lutron - HI-LUME PREMIER 0,1% Eco System 24V/96W
I	- Casambi CBU-A2D-0/10V-DALI-Bluetooth 100/277 VAC
J	- Casambi CBU-PWM4-4CH-Bluetooth 100/277 VAC
K	- Casambi CBU-TED-CV-Trail edge dim-Bluetooth 120 VAC
NO	- No driver

POWER SUPPLY/CONTROL

*NOTES

*The light output is provided in lumens per foot, for a CCT of 4200K and a clear lens. Please refer to the optics page for CCT and translucency conversion factors.

** Only available in 96W - 24V Driver

TITLE 24

ASSEMBLY DIMENSION / DIMENSION D'ASSEMBLAGE

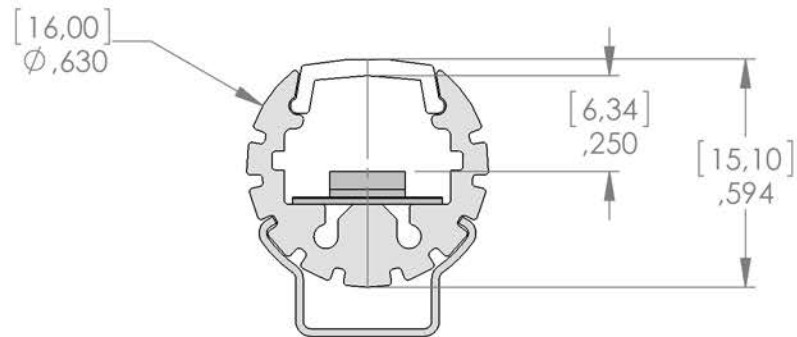
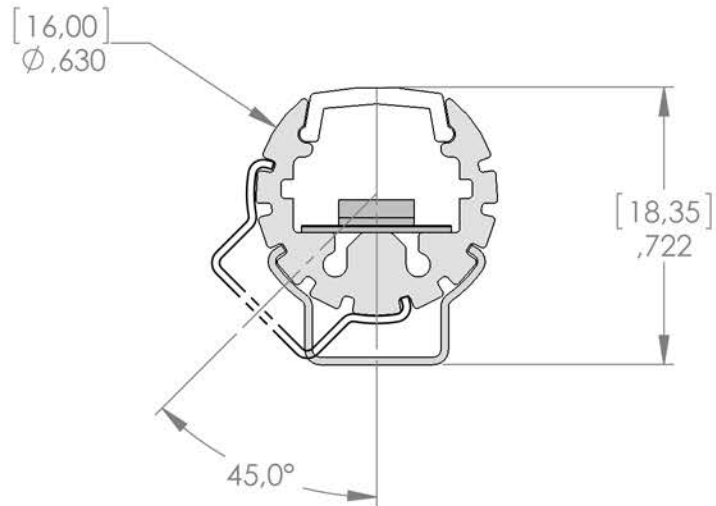

ARM KIT HORIZONTAL DIMENSION / DIMENSIONS DU SUPPORT HORIZONTAL

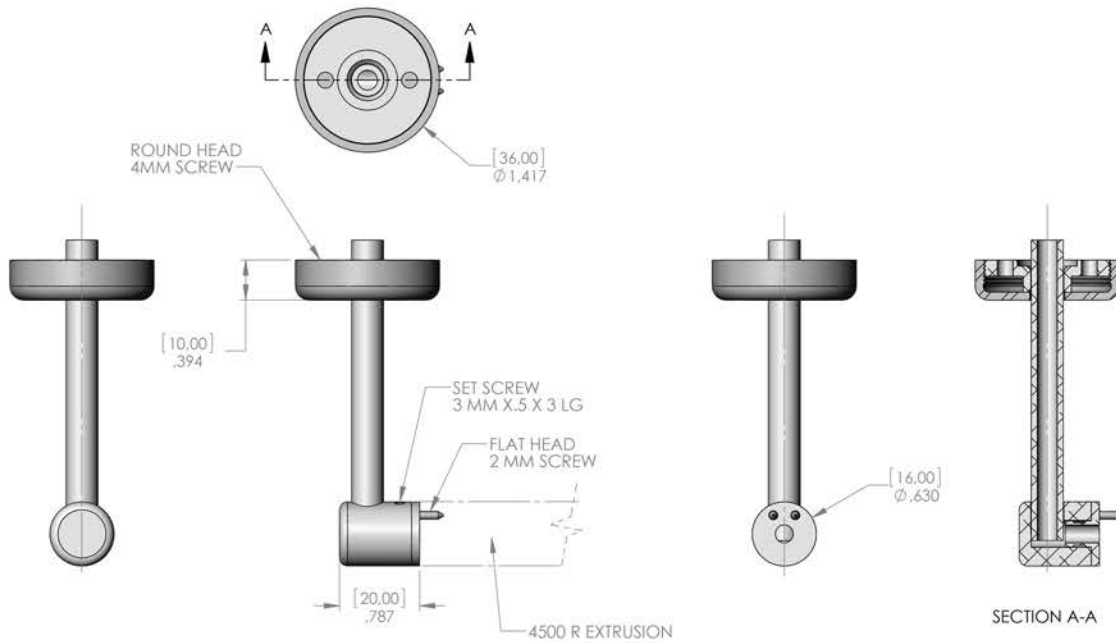

NOTES

