

6900 PROFILE - LUXLINE 120V

6000 Series

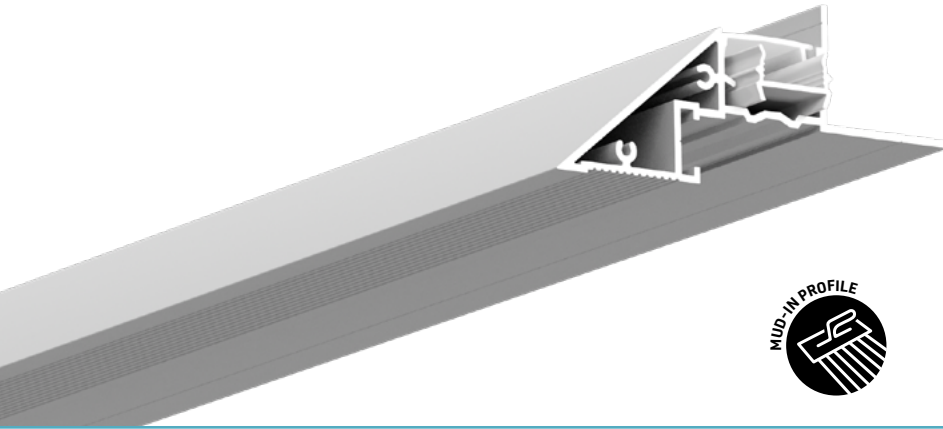

Cross-section dimensions:

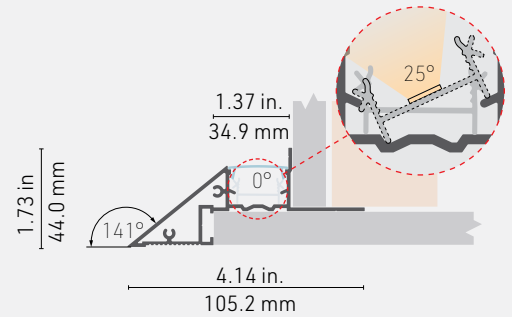

The **6900 Luxline** "Pen Knife" profile is named for being a smaller version of our 8920 Knife and is designed for cove lighting long linear runs. Attain a length up to 164 feet off one roll without any breaks in the light and without the use of any drivers. The aluminum channel directly fits standard gypsum panels for a seamless finish to simplify the construction of the cove detail. The channel incorporates a polycarbonate insert for one strip of 120-volt Luxline LED that sits either at a 0-degree, 25-degree, or -25-degree angle to contour the light at the desired angle. Create a beautiful accent for your space with this innovative mud-in lighting solution.

FEATURES

- Made of ALCOA 6063-T5 aluminum alloy for increased heat dissipation.
- Ordered in length of 96 inches (2.43m), cuttable on site for easy and precise installation.
- A direct fit for standard 5/8" gypsum panels, will also accommodate 1/2" panels with the installation of 1/8" shims onsite.
- The grooved area allows leveling of the profile to the plasterboard using drywall mud.
- Easily connect multiple sections with a variety of type B joiners.
- Each 96-inch section includes a Prime lens for optimal optics and protection from dust.
- Insert to easily install and hold the LED in place.
- Insert can be angled at 0, 25, or -25 degrees.
- No driver needed: 120V LuxLine LED light source.
- LuxLine lumen output: 330 lm / 4.0W ft / 90+ CRI.
- 5 color temperatures (2400 K, 2700 K, 3000 K, 3500K, 4000 K).
- Aluminum channel is field paintable.
- Indoor use.







LED TAPE COMPATIBILITY

Compatible with our LuxLine series of 120V LED engine tape

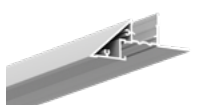



LINEAR WEIGHT

0.762 lbs/ft, 1.134 kg/m, without lenses.



PROFILE	INSERT MOUNT	LENSES	LENGTH	JOINERS
 <p>6900 - Profile</p>	  <p>FIM - Flat insert mount</p> <p>PR - Prime lens</p>	<p>Available in straight section of 8 feet (96 inches/2.4 m).</p>	<p>Available in straight section of 8 feet (96 inches/2.4 m).</p>	 <p>JS - Type B straight joiner</p> <p>JS X</p> <p>JOINER QTY</p>  <p>JH135 - Type B horiz. 135° joiner</p> <p>JH135 X</p> <p>JOINER QTY</p>  <p>JH90 - Type B horiz. 90° joiner</p> <p>JH90 X</p> <p>JOINER QTY</p>  <p>JV90 - Type B vert. 90° joiner</p> <p>JV90 X</p> <p>JOINER QTY</p>
<p>6900</p> <p>PROFILE</p>	<p>FIM</p> <p>INSERT</p>	<p>PR</p> <p>LENS</p>	<p>96" X</p> <p>LENGTH QTY</p>	

6000

COLOR TEMPERATURE	LUMEN PACKAGE*	LEAD IN	USAGE	NOTES
 24 - 2400K  27 - 2700K  30 - 3000K  35 - 3500K  40 - 4000K <p>COLOR TEMPERATURE CCT</p>	<p>LUX - 330 LM / 4.0W FT / 90+CRI</p> <p>LUX</p> <p>LUMEN PACKAGE</p>	<p>HW3 - Hardwire 36" HW6 - Hardwire 72" HW9 - Hardwire 108" HWX - Hardwire custom</p> <p>LEAD IN</p>	<p>2 - IP64 indoor</p> <p>IP64</p> <p>IP RATING</p>	<p>* The light output is provided in lumens per foot, for a CCT of 4000K and no lens.</p>

LUXLINE FEATURES

- LumenTruss Driverless technology.
- Direct line voltage.
- Constant current IC providing uniform intensity over the entire run.
- Uses North American power plug with built-in fuse or hardwire.
- Order in lengths of 1 FT.
- 164 FT maximum run.
- Ultra high lumen output.
- Architectural grade.
- PVC coating (not recommended for direct sunlight).
- 3 year warranty.
- Life of 50,000 hours
- LED type: 3056
- WARNING: Do not cut AC plug.

LUXLINE FEATURES

Plug-in Connection Diagram

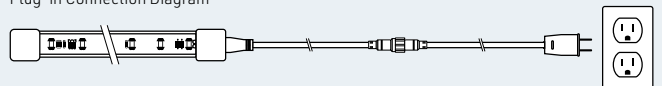

Hardwire Connection Diagram

With the NEW revolutionary hardwire connection with built-in fuse! Exclusive to LumenTruss.

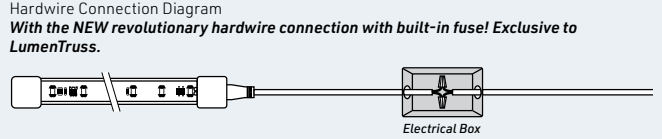

Electrical Box