

8900 PROFILE (KNIFE EDGE)

8000 Series

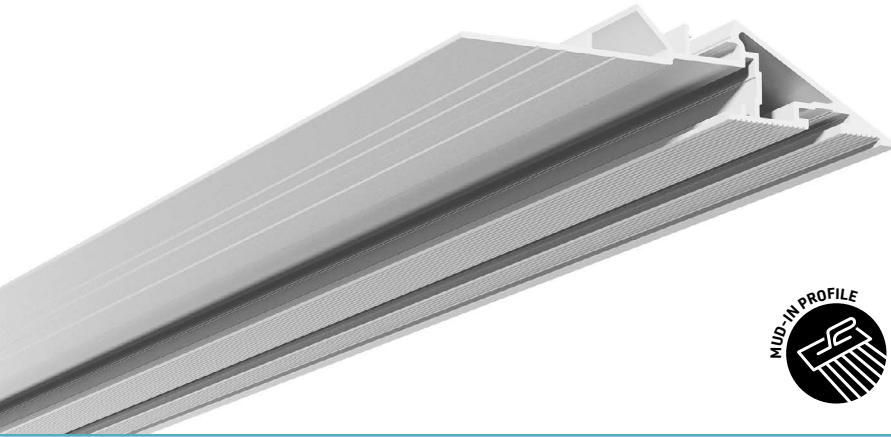

Cross-section dimensions:

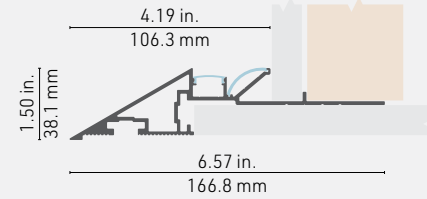

The 8900 "Knife Edge" profile makes the construction of **edgeless coves and drop ceiling soffits** a breeze. Its direct fit for standard gypsum panels allows for a seamless finish. Two integrated LED channels allow you to **add contour lighting, fill space with light, or both**. Build rectangular shapes using pre-built corners and straight line extrusions, tune the light with your choice of LED engines, paint to match, and you're done!

FEATURES

- A direct fit for standard 5/8" gypsum panels, will also accommodate 1/2" panels with the installation of 1/8" shims onsite.
- The grooved area allows to level the profile to the plasterboard using drywall mud.
- Two different LED channels, a 90 degrees to focus the light in the cove, a 40 degrees to wash of the ceiling, use both for a maximum indirect lighting.
- The LED channels are designed for up to 14mm wide LED light engine. Are to be ordered to desired lengths for easier installation.
- Ordered in length of 96 inches (2.43m), cuttable on site for easy and precise installation.
- Available for easier installation, 2 types of pre-made corners, inside corner (8901) lighting on 90 degree, and outside corner (8902) lighting on 270 degree.
- Each 96" inch section and corners includes both series 1000 Standard (1261) and 2000 round Optiflex (2034) lenses.
- Made of ALCOA 6063-T5 aluminum alloy for increased heat dissipation.
- Designed to meet North American woodworking standards.

OPTIONS



LED ENGINE COMPATIBILITY

Both LED channels are compatible with LED engines up to **14mm** wide.

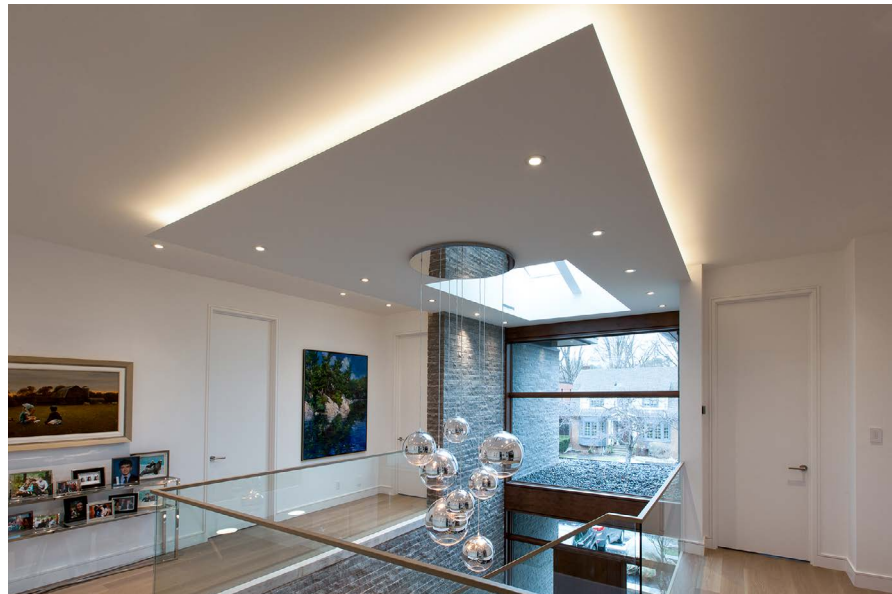

LINEAR WEIGHT

1.288 lbs/ft, 1.916 kg/m, without lenses.



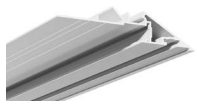

8900 Profile (KNIFE EDGE) ordering sheet

8000 Series

PROFILE	LENGTH	90° UP LENS	40° SIDE LENS
 8900 - Profile	Available in straight section of 8 feet (96 inches/2.4 m).	 OX - Optiflex lens	 OXR - Optiflex lens, round
KIT QUANTITY	X 96 INCHES LENGTH	INCLUDED WITH EACH PROFILE	INCLUDED WITH EACH PROFILE

EXTRA ACCESSORIES

 JS - Type C straight joiner	 JH45 - Type C horiz. 45° joiner	 JH90 - Type C horiz. 90° joiner	 JV90 - Type C vert. 90° joiner	 JV45 - Type C vert. 45° joiner
QUANTITY	QUANTITY	QUANTITY	QUANTITY	QUANTITY



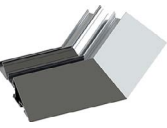











PRE-MADE CORNERS

 I90 - Inside corner 90°	 O270 - Outside corner 270°	 I45 - Inside corner 45°	 O45 - Outside corner 45°
QUANTITY	QUANTITY	QUANTITY	QUANTITY

LENS + ACCESSORIES

90° UP LENS OX - Optiflex lens
40° SIDE LENS OXR - Optiflex lens, round
INCLUDED WITH EACH CORNER

LED engine will be assembled on site. See Appendix 3 on page 261 to see how to calculate total ordering length.

COLOR TEMPERATURE	LUMEN PACKAGE*	LEAD IN/OUT	USAGE	POWER SUPPLY/CONTROL	LENGTH
<ul style="list-style-type: none">  24 - 2400K  27 - 2700K  30 - 3000K  35 - 3500K  42 - 4200K  53 - 5300K (LHP only)  62 - 6200K (LP only)  WD1 - 2200-2700K 14W  WD3 - 2700-3500K 14W  TW1 - Tunable White 11W  TW2 - Tunable White 19W  RGB1 - RGB 14W  RGB2 - RGB 19W  RGBW1 - 3000K  RGBW2 - 3000K 4in1 	<p>LP0 - 128 LM / 1.5W FT / 90+CRI LP1 - 160 LM / 1.5W FT / 90+CRI LP2 - 255 LM / 3.0W FT / 90+CRI LP3 - 308 LM / 4.5W FT / 90+CRI LP4 - 400 LM / 5.8W FT / 90+CRI LHP - 700 LM / 7.0W FT / 95+CRI</p> <p>Note: Not applicable for Warmdim (WD), Tunable White (TW) & RGB color temperatures</p>	<p>HW3 - Hardwire 3 FT HW6 - Hardwire 6 FT HW9 - Hardwire 9 FT HWX - Hardwire custom FT NO - No lead</p>	I - IP22 indoor dry location	<p>A - Non-dimming B - ELV dimming 120V AC C - ELV dimming 120/277 VAC** D - 0/10V dimming 120/277 VAC E - Non-dimming DC plug in F - DMX G - Lutron - HI-LUME PREMIER 0,1% Eco System 24V/96W I - Casambi CBU-A2D-0/10V-DALI-Bluetooth 100/277 VAC J - Casambi CBU-PWM4-4CH-Bluetooth 100/277 VAC K - Casambi CBU-TED-CV-Trail edge dim-Bluetooth 120 VAC NO - No driver</p>	<p>Total length of LED engine in inches - See Appendix 3 (page 261) on how to calculate length.</p>
COLOR TEMPERATURE CCT	LUMEN PACKAGE	LEAD IN LEAD OUT	USAGE	POWER SUPPLY/CONTROL	LED ENGINE LENGTH
COLOR TEMPERATURE CCT	LUMEN PACKAGE	LEAD IN LEAD OUT	USAGE	POWER SUPPLY/CONTROL	LED ENGINE LENGTH
COLOR TEMPERATURE CCT	LUMEN PACKAGE	LEAD IN LEAD OUT	USAGE	POWER SUPPLY/CONTROL	LED ENGINE LENGTH

*NOTE: The light output is provided in lumens per foot, for a CCT of 4200K and a clear lens. Please refer to the optics page for CCT and translucency conversion factors. **Only available in 96W - 24V Driver

TITLE 24

NOTES

