

PIKE

Wood Series

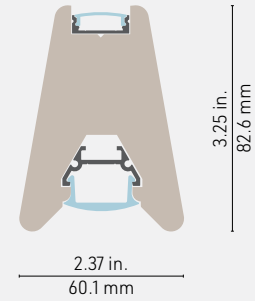

Cross-section dimensions:



Go edgy and playful with a youthful approach on the classic of wood. The **PIKE** is the profile with the **most discreet light source** in the series, for a fresh yet unobtrusive visual presence that is particularly fit for social spaces, whether recreational or collaborative.

FEATURES

- Engineered from sustainably harvested and recycled hardwood, for superior mechanical quality and to bring out the natural wood texture.
- Designed to give a uniform light without hot spots with an Optiflex, Opal, or Prime lens.
- Custom length by sections of 12 to 144 inches (3.6m).
- Application guide for 10mm (3/8-inch) LED engine or less.
- The insert is made of ALCOA 6063-T5 aluminum alloy increasing heat dissipation.
- Available in varnished finish.
- Natural finish available on special order with a setup fee. (With this option client can apply their own finish to match with their decor.)

OPTIONS





















LED ENGINE COMPATIBILITY

Compatible with LED engines or PCBs up to **14mm** wide.

LINEAR WEIGHT

1.275 lbs/ft, 1.898 kg/m (without lens or insert)



PROFILE	LENS DOWN	LENS UP	MOUNTING HARDWARE	CANOPY	LENGTH
 <p>PIKV - Wood enclosure, varnished finish Aluminum heat sink included with profiles</p>	 <p>CL - Clear lens</p>	 <p>CL - Clear lens</p>  <p>SP - Spread lens</p>  <p>OX - Optiflex lens</p>  <p>OP - Opal lens</p>  <p>PR - Prime lens</p>  <p>NO - No lens</p>	 <p>SUS - Suspension kit with 15ft. aircraft cable</p>	 <p>Remote driver canopy plate See Appendix 2 on page 260 CR0 - Alu CR1 - Black CR2 - White</p>  <p>Integrated driver in canopy See Appendix 2 on page 260 CI0 - Alu CI1 - Black CI2 - White</p>  <p>Integrated driver & suspension kit See Appendix 2 on page 260 CIK0 - Alu CIK1 - Black CIK2 - White</p>  <p>NO - No canopy</p>	<p>Custom length by sections of 12 to 144 inches (3.6m), in increments of 12 inches (30cm).</p> <p>By default suspension will be installed 6 inches (15.3cm) from the ends of the profile. For custom options please contact your local representative.</p>
 <p>PIKN - Wood enclosure, nature finish (special order only; setup fees will be applied) Aluminum heat sink included with profiles</p>	 <p>OX - Optiflex lens</p>  <p>OP - Opal lens</p>  <p>PR - Prime lens</p>  <p>NO - No Lens</p>	<p>NO - No lens</p>	<p>SUS</p>	<p>NO - No canopy</p>	
PROFILE	LENS DOWN	LENS UP	MOUNTING HARDWARE	CANOPY	LENGTH

COLOR TEMPERATURE	LM PACKAGE DOWN/UP*	USAGE	POWER SUPPLY/CONTROL**	*NOTES	
<p>24 - 2400K</p> <p>27 - 2700K</p> <p>30 - 3000K</p> <p>35 - 3500K</p> <p>42 - 4200K</p> <p>53 - 5300K (LHP only)</p> <p>62 - 6200K (LP only)</p> <p>WD1 - 2200-2700K 14W</p> <p>WD3 - 2700-3500K 14W</p> <p>TW1 - Tunable White 11W</p> <p>TW2 - Tunable White 19W</p> <p>RGB1 - RGB 14W</p> <p>RGB2 - RGB 19W</p> <p>RGBW1 - 3000K</p> <p>RGBW2 - 3000K 4in1</p> <p>NO - No up light (w/ opal lens)</p>	<p>LP0 - 128 LM / 1.5W FT / 90+CRI</p> <p>LP1 - 160 LM / 1.5W FT / 90+CRI</p> <p>LP2 - 255 LM / 3.0W FT / 90+CRI</p> <p>LP3 - 308 LM / 4.5W FT / 90+CRI</p> <p>LP4 - 400 LM / 5.8W FT / 90+CRI</p> <p>LHP - 700 LM / 7.0W FT / 95+CRI</p> <p>Note: Not applicable for Warmdim (WD), Tunable White (TW) & RGB color temperatures</p>	<p>I - IP22 indoor dry location</p>	<p>A - Non-dimming</p> <p>B - ELV dimming 120V AC</p> <p>C - ELV dimming 120/277 VAC***</p> <p>D - 0/10V dimming 120/277 VAC</p> <p>F - DMX</p> <p>G - Lutron - HI-LUME PREMIER 0,1% Eco System 24V/96W</p> <p>I - Casambi CBU-A2D-0/10V-DALI-Bluetooth 100/277 VAC</p> <p>J - Casambi CBU-PWM4-4CH-Bluetooth 100/277 VAC</p> <p>K - Casambi CBU-TED-CV-Trail edge dim-Bluetooth 120 VAC</p> <p>NO - No driver</p>	<p>* The light output is provided in lumens per foot, for a CCT of 4200K and a clear lens. Please refer to the optics page for CCT and translucency conversion factors.</p> <p>** By default both Up & Down LED engines are controlled from one source. For custom options, please contact your local representative.</p> <p>*** Only available in 96W - 24V Driver</p>	
CCT DOWN	CCT UP	LM DOWN	LM UP	USAGE	POWER SUPPLY/CONTROL

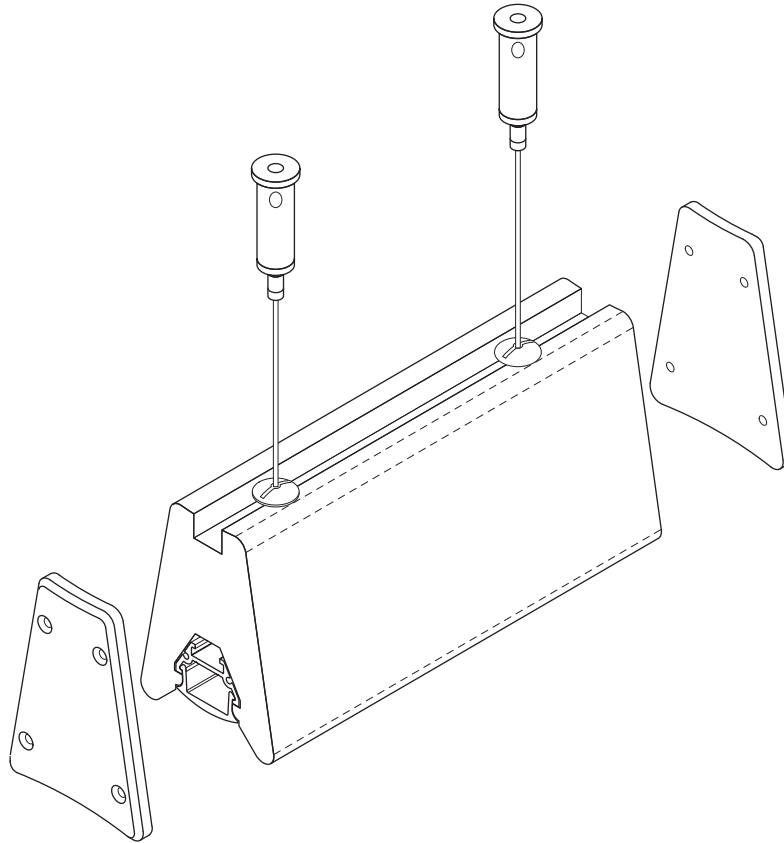

ASSEMBLY DIMENSION / DIMENSION D'ASSEMBLAGE

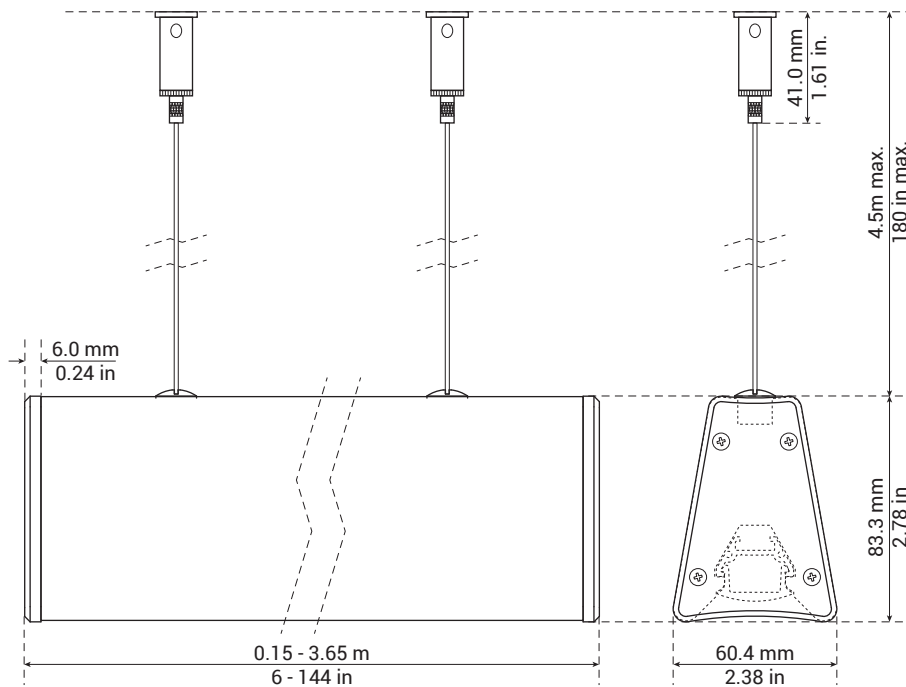

NOTES

