

# TIGA

Wood Series

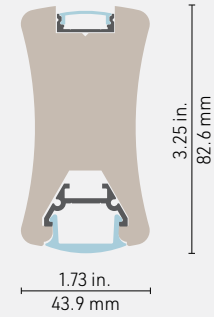

## Cross-section dimensions:



Go for the warmth of the **natural essence of wood**. Liven up your spaces with our ecological lighting fixtures made of recycled wood from Quebec. The slim **TIGA** will match any décor with its smoothed out sides, and can be combined with a linear canopy for extra style.

## FEATURES

- Engineered from sustainably harvested and recycled hardwood, for superior mechanical quality and to bring out the natural wood texture.
- Designed to give a uniform light without hot spots with an Optiflex, Opal, or Prime lens.
- Custom length by sections of 12 to 144 inches (3.6m).
- Application guide for 10mm (3/8-inch) LED engine or less.
- The insert is made of ALCOA 6063-T5 aluminum alloy increasing heat dissipation.
- Available in varnished finish.
- Natural finish available on special order with a setup fee. (With this option client can apply their own finish to match with their decor.)

## OPTIONS





















## LED ENGINE COMPATIBILITY

Compatible with LED engines or PCBs up to **14mm** wide.

## LINEAR WEIGHT

1.141 lbs/ft, 1.699 kg/m (without lens or insert)



PROFILE	LENS DOWN	LENS UP	MOUNTING HARDWARE	CANOPY	LENGTH
 <p><b>TIGV</b> - Wood enclosure, varnished finish Aluminum heat sink included with profiles</p>	 <p><b>CL</b> - Clear lens</p>	 <p><b>CL</b> - Clear lens</p>  <p><b>SP</b> - Spread lens</p>	 <p><b>SUS</b> - Suspension kit with 15ft. aircraft cable</p>	 <p><b>Remote driver canopy plate</b> See Appendix 2 on page 260 <b>CR0</b> - Alu <b>CR1</b> - Black <b>CR2</b> - White</p>	<p>Custom length by sections of 12 to 144 inches (3.6m), in increments of 12 inches (30cm).</p> <p>By default suspension will be installed 6 inches (15.3cm) from the ends of the profile. For custom options please contact your local representative.</p>
 <p><b>TIGN</b> - Wood enclosure, nature finish (special order only; setup fees will be applied) Aluminum heat sink included with profiles</p>	 <p><b>OX</b> - Optiflex lens</p>	 <p><b>OX</b> - Optiflex lens</p>  <p><b>OP</b> - Opal lens</p>  <p><b>PR</b> - Prime lens</p>  <p><b>NO</b> - No lens</p>		 <p><b>Integrated driver in canopy</b> See Appendix 2 on page 260 <b>CI0</b> - Alu <b>CI1</b> - Black <b>CI2</b> - White</p>	
	 <p><b>OP</b> - Opal lens</p>  <p><b>PR</b> - Prime lens</p>  <p><b>NO</b> - No Lens</p>		<div style="border: 1px solid black; padding: 5px; text-align: center;"><b>SUS</b></div>	 <p><b>Integrated driver &amp; suspension kit</b> See Appendix 2 on page 260 <b>CIK0</b> - Alu <b>CIK1</b> - Black <b>CIK2</b> - White</p>  <p><b>NO</b> - No canopy</p>	
PROFILE	LENS DOWN	LENS UP	MOUNTING HARDWARE	CANOPY	LENGTH

COLOR TEMPERATURE	LM PACKAGE DOWN/UP*	USAGE	POWER SUPPLY/CONTROL**	*NOTES	
<p><b>24</b> - 2400K</p> <p><b>27</b> - 2700K</p> <p><b>30</b> - 3000K</p> <p><b>35</b> - 3500K</p> <p><b>42</b> - 4200K</p> <p><b>53</b> - 5300K (LHP only)</p> <p><b>62</b> - 6200K (LP only)</p> <p><b>WD1</b> - 2200-2700K 14W</p> <p><b>WD3</b> - 2700-3500K 14W</p> <p><b>TW1</b> - Tunable White 11W</p> <p><b>TW2</b> - Tunable White 19W</p> <p><b>RGB1</b> - RGB 14W</p> <p><b>RGB2</b> - RGB 19W</p> <p><b>RGBW1</b> - 3000K</p> <p><b>RGBW2</b> - 3000K 4in1</p> <p><b>NO</b> - No up light (w/ opal lens)</p>	<p><b>LP0</b> - 128 LM / 1.5W FT / 90+CRI</p> <p><b>LP1</b> - 160 LM / 1.5W FT / 90+CRI</p> <p><b>LP2</b> - 255 LM / 3.0W FT / 90+CRI</p> <p><b>LP3</b> - 308 LM / 4.5W FT / 90+CRI</p> <p><b>LP4</b> - 400 LM / 5.8W FT / 90+CRI</p> <p><b>LHP</b> - 700 LM / 7.0W FT / 95+CRI</p> <p><b>Note:</b> Not applicable for Warmdim (WD), Tunable White (TW) &amp; RGB color temperatures</p>	<p><b>I</b> - IP22 indoor dry location</p>	<p><b>A</b> - Non-dimming</p> <p><b>B</b> - ELV dimming 120V AC</p> <p><b>C</b> - ELV dimming 120/277 VAC***</p> <p><b>D</b> - 0/10V dimming 120/277 VAC</p> <p><b>F</b> - DMX</p> <p><b>G</b> - Lutron - HI-LUME PREMIER 0,1% Eco System 24V/96W</p> <p><b>I</b> - Casambi CBU-A2D-0/10V-DALI-Bluetooth 100/277 VAC</p> <p><b>J</b> - Casambi CBU-PWM4-4CH-Bluetooth 100/277 VAC</p> <p><b>K</b> - Casambi CBU-TED-CV-Trail edge dim-Bluetooth 120 VAC</p> <p><b>NO</b> - No driver</p>	<p>* The light output is provided in lumens per foot, for a CCT of 4200K and a clear lens. Please refer to the optics page for CCT and translucency conversion factors.</p> <p>** By default both Up &amp; Down LED engines are controlled from one source. For custom options, please contact your local representative.</p> <p>*** Only available in 96W - 24V Driver</p> <div style="border: 1px solid black; padding: 5px; text-align: center;"> <p>TITLE</p> <p><b>24</b></p> <p>CONTRACT</p> </div>	
CCT DOWN	CCT UP	LM DOWN	LM UP	USAGE	POWER SUPPLY/CONTROL

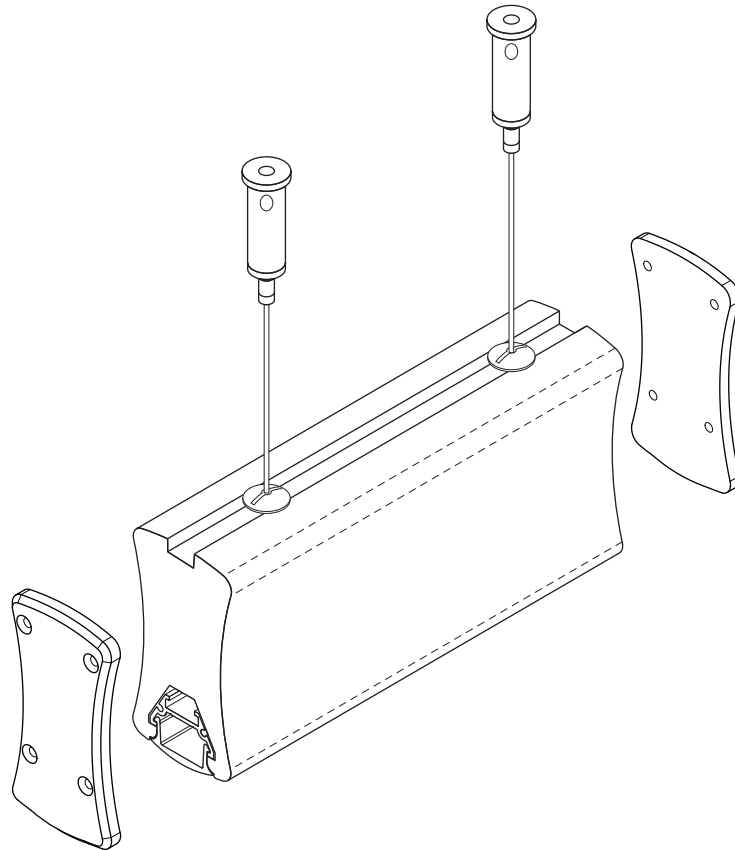

ASSEMBLY DIMENSION / DIMENSION D'ASSEMBLAGE

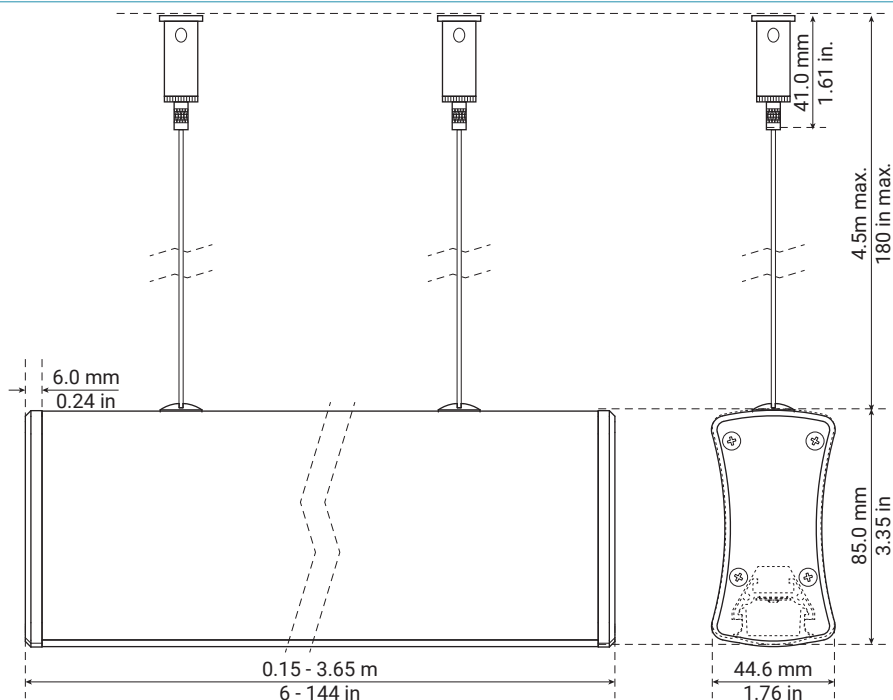

# NOTES

