

TOOBYFOR

Wood Series

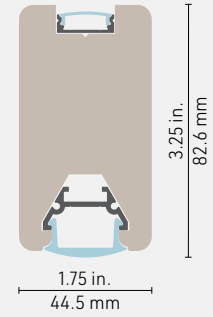

Cross-section dimensions:



The **simplicity and minimalism** of **TOOBYFOR** makes it a welcome accent in contemporary spaces. Like the rest of our Wood Series, it is engineered from recycled hardwood, for natural warmth and superior quality. It is durable with its rugged build and an aircraft-grade suspension cable, but brings a lightweight and modern touch to any interior.

FEATURES

- Engineered from sustainably harvested and recycled hardwood, for superior mechanical quality and to bring out the natural wood texture.
- Designed to give a uniform light without hot spots with an Optiflex, Opal, or Prime lens.
- Custom length by sections of 12 to 144 inches (3.6m).
- Application guide for 10mm (3/8-inch) LED engine or less.
- The insert is made of ALCOA 6063-T5 aluminum alloy increasing heat dissipation.
- Available in varnished finish.
- Natural finish available on special order with a setup fee. (With this option client can apply their own finish to match with their decor.)

OPTIONS











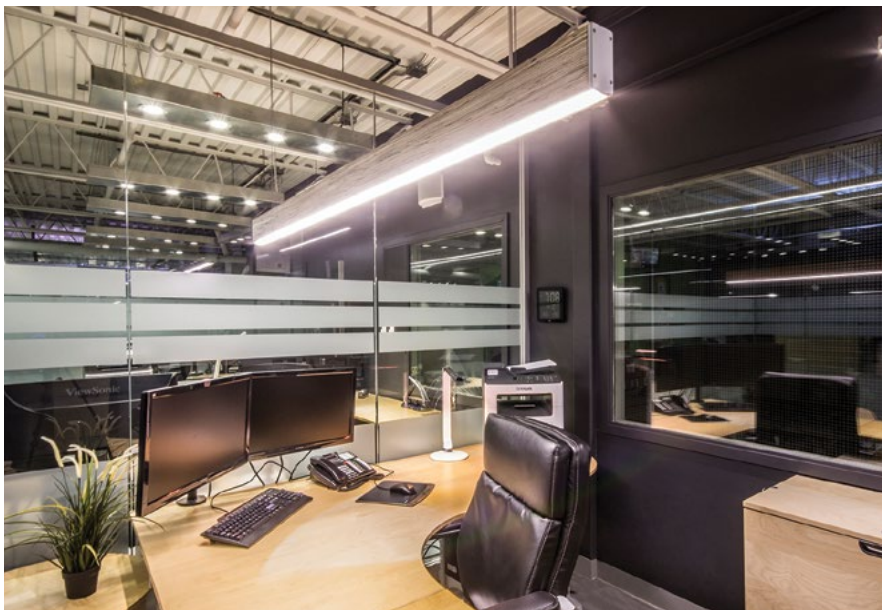









LED ENGINE COMPATIBILITY

Compatible with LED engines or PCBs up to **14mm** wide.

LINEAR WEIGHT

1.385 lbs/ft, 2.060 kg/m (without lens or insert)



PROFILE	LENS DOWN	LENS UP	MOUNTING HARDWARE	CANOPY	LENGTH
 <p>Toov - Wood enclosure, varnished finish Aluminum heat sink included with profiles</p>	 <p>CL - Clear lens</p>	 <p>CL - Clear lens</p>	 <p>SUS - Suspension kit with 15ft. aircraft cable</p>	 <p>Remote driver canopy plate See Appendix 2 on page 260 CR0 - Alu CR1 - Black CR2 - White</p>	<p>Custom length by sections of 12 to 144 inches (3.6m), in increments of 12 inches (30cm).</p> <p>By default suspension will be installed 6 inches (15.3cm) from the ends of the profile. For custom options please contact your local representative.</p>
 <p>TOON - Wood enclosure, nature finish (special order only; setup fees will be applied) Aluminum heat sink included with profiles</p>	 <p>OX - Optiflex lens</p>	 <p>SP - Spread lens</p>		 <p>Integrated driver in canopy See Appendix 2 on page 260 CI0 - Alu CI1 - Black CI2 - White</p>	
	 <p>OP - Opal lens</p>	 <p>OX - Optiflex lens</p>		 <p>Integrated driver & suspension kit See Appendix 2 on page 260 CIK0 - Alu CIK1 - Black CIK2 - White</p>	
	 <p>PR - Prime lens</p>	 <p>OP - Opal lens</p>		 <p>NO - No canopy</p>	
	 <p>NO - No Lens</p>	 <p>PR - Prime lens</p>	<div style="border: 1px solid black; padding: 5px; text-align: center;">SUS</div>		
PROFILE	LENS DOWN	LENS UP	MOUNTING HARDWARE	CANOPY	LENGTH

COLOR TEMPERATURE	LM PACKAGE DOWN/UP*	USAGE	POWER SUPPLY/CONTROL**	*NOTES
<p>24 - 2400K</p> <p>27 - 2700K</p> <p>30 - 3000K</p> <p>35 - 3500K</p> <p>42 - 4200K</p> <p>53 - 5300K (LHP only)</p> <p>62 - 6200K (LP only)</p> <p>WD1 - 2200-2700K 14W</p> <p>WD3 - 2700-3500K 14W</p> <p>TW1 - Tunable White 11W</p> <p>TW2 - Tunable White 19W</p> <p>RGB1 - RGB 14W</p> <p>RGB2 - RGB 19W</p> <p>RGBW1 - 3000K</p> <p>RGBW2 - 3000K 4in1</p> <p>NO - No up light (w/ opal lens)</p>	<p>LP0 - 128 LM / 1.5W FT / 90+CRI</p> <p>LP1 - 160 LM / 1.5W FT / 90+CRI</p> <p>LP2 - 255 LM / 3.0W FT / 90+CRI</p> <p>LP3 - 308 LM / 4.5W FT / 90+CRI</p> <p>LP4 - 400 LM / 5.8W FT / 90+CRI</p> <p>LHP - 700 LM / 7.0W FT / 95+CRI</p> <p>Note: Not applicable for Warmdim (WD), Tunable White (TW) & RGB color temperatures</p>	<p>I - IP22 indoor dry location</p>	<p>A - Non-dimming</p> <p>B - ELV dimming 120V AC</p> <p>C - ELV dimming 120/277 VAC***</p> <p>D - 0/10V dimming 120/277 VAC</p> <p>F - DMX</p> <p>G - Lutron - HI-LUME PREMIER 0,1% Eco System 24V/96W</p> <p>I - Casambi CBU-A2D-0/10V-DALI-Bluetooth 100/277 VAC</p> <p>J - Casambi CBU-PWM4-4CH-Bluetooth 100/277 VAC</p> <p>K - Casambi CBU-TED-CV-Trail edge dim-Bluetooth 120 VAC</p> <p>NO - No driver</p>	<p>* The light output is provided in lumens per foot, for a CCT of 4200K and a clear lens. Please refer to the optics page for CCT and translucency conversion factors.</p> <p>** By default both Up & Down LED engines are controlled from one source. For custom options, please contact your local representative.</p> <p>*** Only available in 96W - 24V Driver</p> <div style="border: 1px solid black; padding: 5px; text-align: center;"> <p>TITLE</p> <p>24</p> <p>CONVERT</p> </div>
CCT DOWN	CCT UP	LM DOWN	LM UP	USAGE
				POWER SUPPLY/CONTROL

TOOBYFOR (0401) LM40100

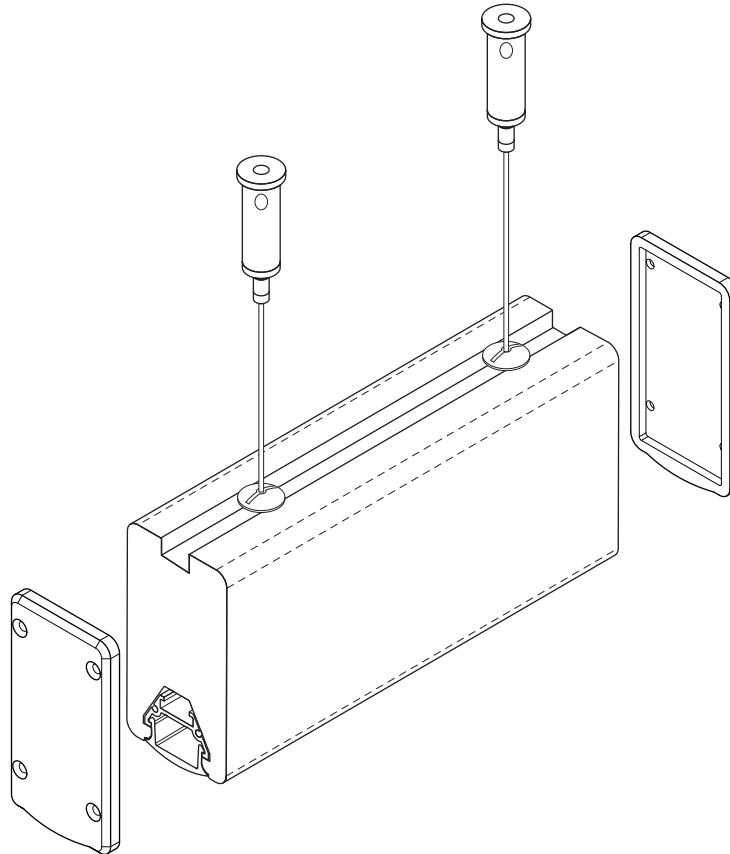

ASSEMBLY DIMENSION / DIMENSION D'ASSEMBLAGE

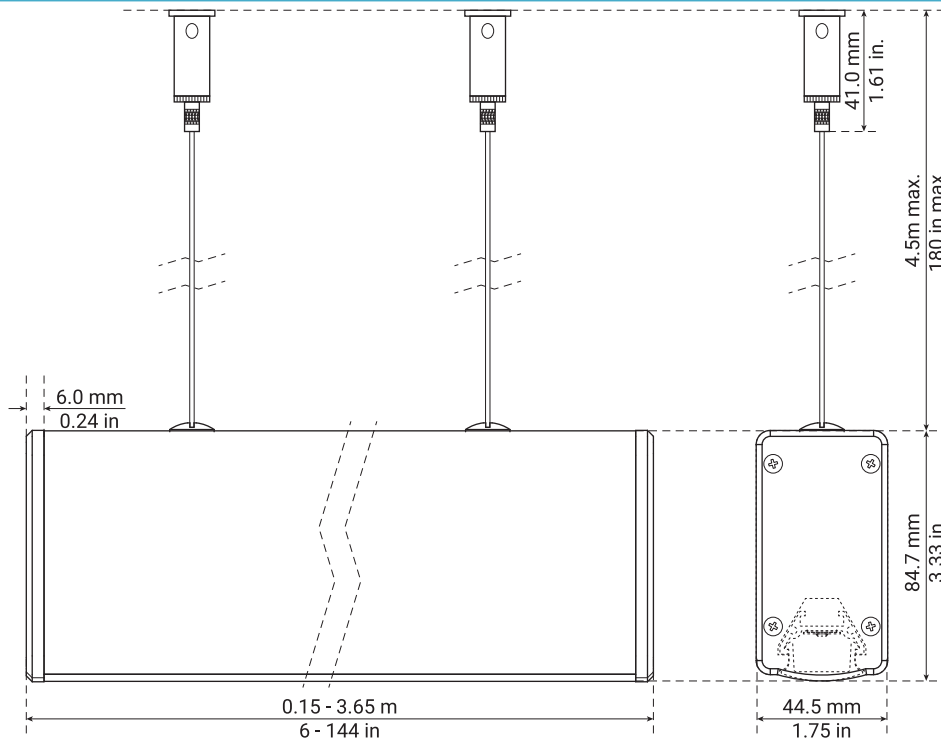

NOTES

